



BLACK FOSTER
THE INVISIBLE BLACK, EN UN SISTEMA LINEAL

ARKOSLIGHT®

BLACK FOSTER

CUSTOM · RECESSED · TRIMLESS · SURFACE · SUSPENDED · SPOTLIGHTS



ARKOSLIGHT®

THE INVISIBLE BLACK, EN UN SISTEMA LINEAL

Black Foster es el nuevo producto de Arkoslight que traslada el aclamado efecto "The Invisible Black" a un sistema lineal. Esta característica tecnológica de iluminación permite a Black Foster ocultar el origen de la luz y al mismo tiempo bañar la escena y generar un efecto espectacular: luz en el espacio sin fuente visible.



LA MISMA ESTÉTICA, TANTO APAGADA COMO ENCENDIDA

Al ocultar el origen de la luz, Black Foster consigue mantener siempre el mismo aspecto, tanto encendida como apagada.

Esto crea una sensación psicológica atractiva en el espectador, que percibe la luz en la sala, pero queda sorprendido al ver que la luminaria está aparentemente apagada.





UNA LÍNEA OSCURA PERFECTA

La homogeneidad de la línea oscura que se consigue a lo largo de Black Foster "Custom" es un aliado del orden, la neutralidad y la elegancia visual en el diseño de espacios.

Con Black Foster, la iluminación se convierte en minimalista y no invasiva, por lo que la luminaria pasa inadvertida y renuncia a ser el centro de atención.

TOTALMENTE PERSONALIZABLE

Formada por segmentos combinables (con y sin emisión de luz), la modularidad de Black Foster "Custom" ofrece una flexibilidad de composición total. El cliente podrá configurar su propia línea oscura y situar libremente en ella la emisión de luz, ya que ambos tipos de segmentos son, visualmente, casi indistinguibles una vez instalados.





THE INVISIBLE BLACK & LUZ DE PROYECCIÓN

Black Foster Custom integra los focos Plus, Six y Fit, para combinar el efecto 'Invisible Black' con iluminación de proyección, al tiempo que mantiene una estética elegante y discreta.

Los proyectores se pueden instalar fácilmente en su recorrido y adaptarse a las necesidades de cada proyecto. Además de Plus Mini, Six S y Fit 35, la amplia gama de proyectores Arkoslight está disponible bajo demanda.

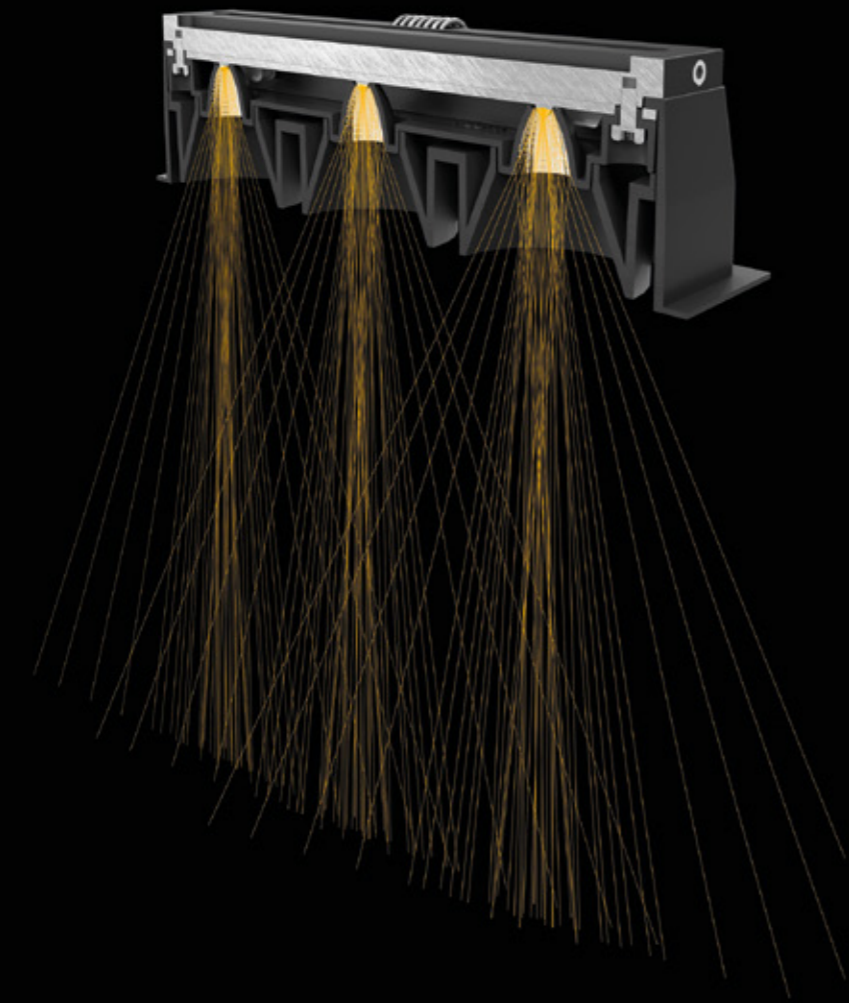

HAZ DE LUZ HIPERCONTROLADO

Además de ser una excelente luminaria para la función de iluminación general, Black Foster es un elemento perfecto para ofrecer iluminación de apoyo o destacar ciertos elementos de diseño interiores como se desea. Mientras que en la función de iluminación general pone de relieve su bajo deslumbramiento y alto confort visual, en la función de realzado se beneficia de su haz de luz perfectamente controlado que maximiza el flujo de luz LED.

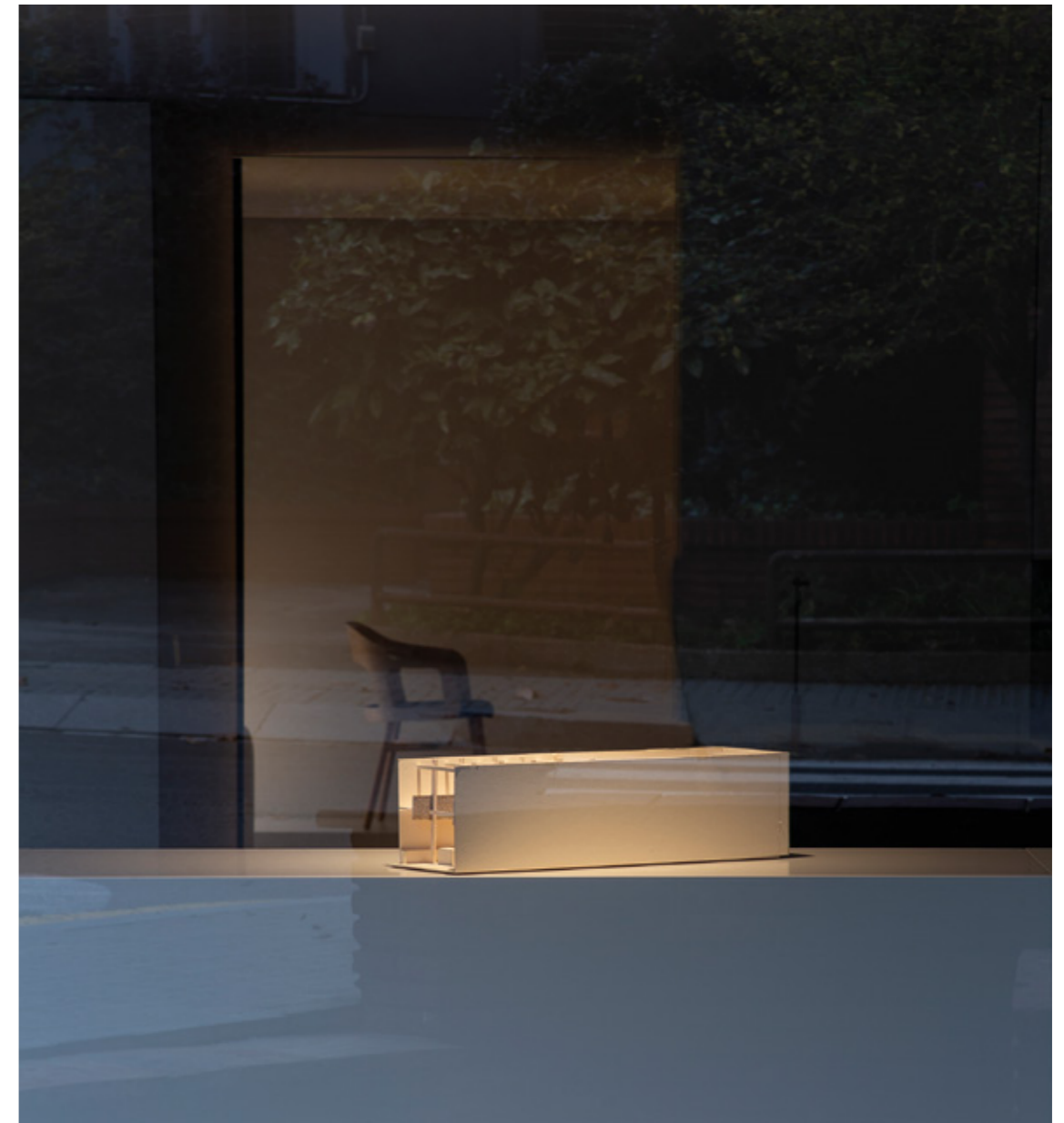



DESLUMBRAMIENTO MUY BAJO

La tecnología Black Foster reduce el efecto de deslumbramiento hasta un nivel muy bajo gracias al elevado control de haz, que concentra los rayos de luz de modo que fluyen hacia el exterior sin apenas desviaciones del ángulo delimitado. Por otro lado, su pantalla antideslumbramiento en acabado “negro técnico” absorbe la más mínima pérdida y evita que la pieza brille o refleje la luz.

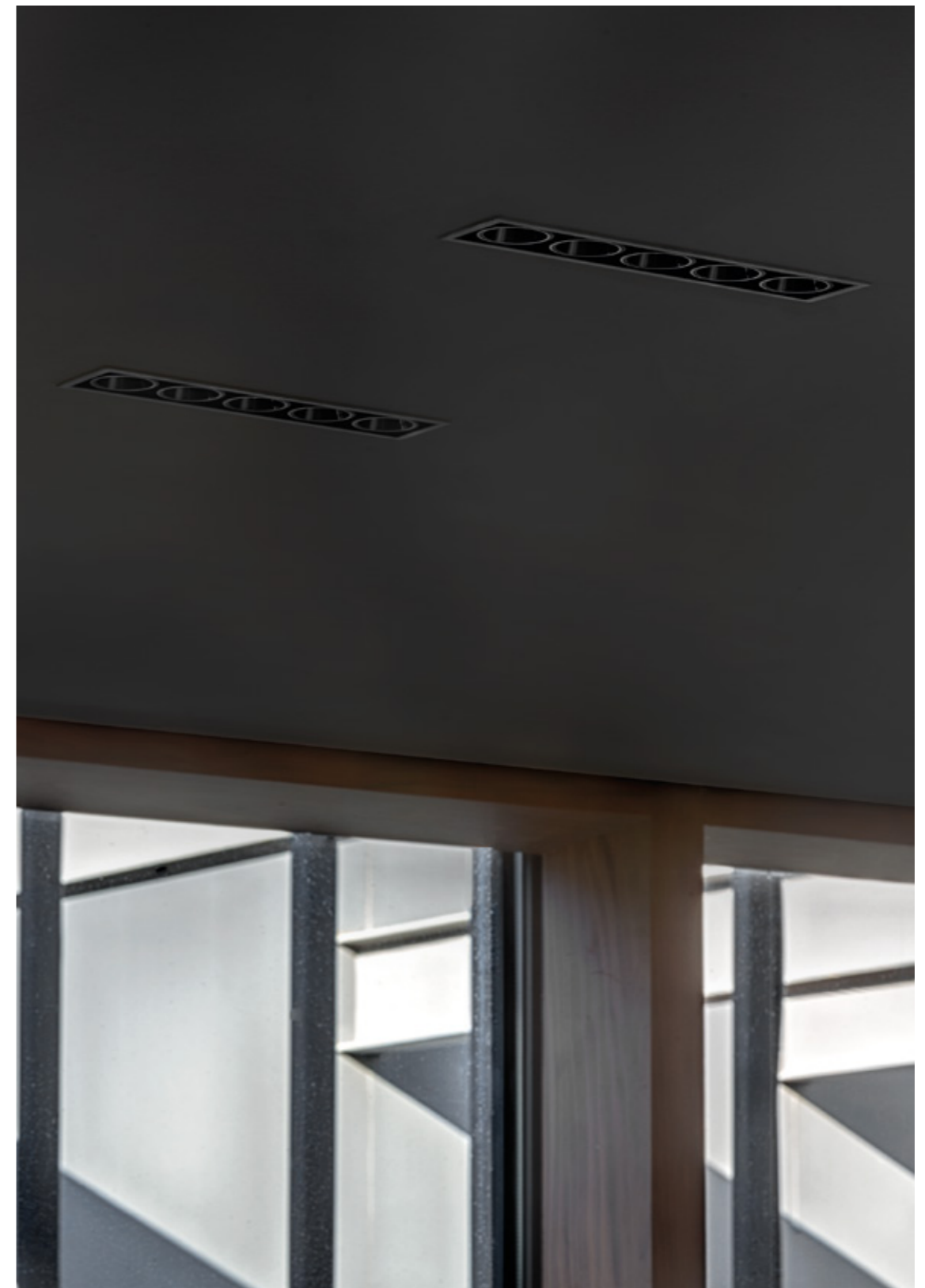

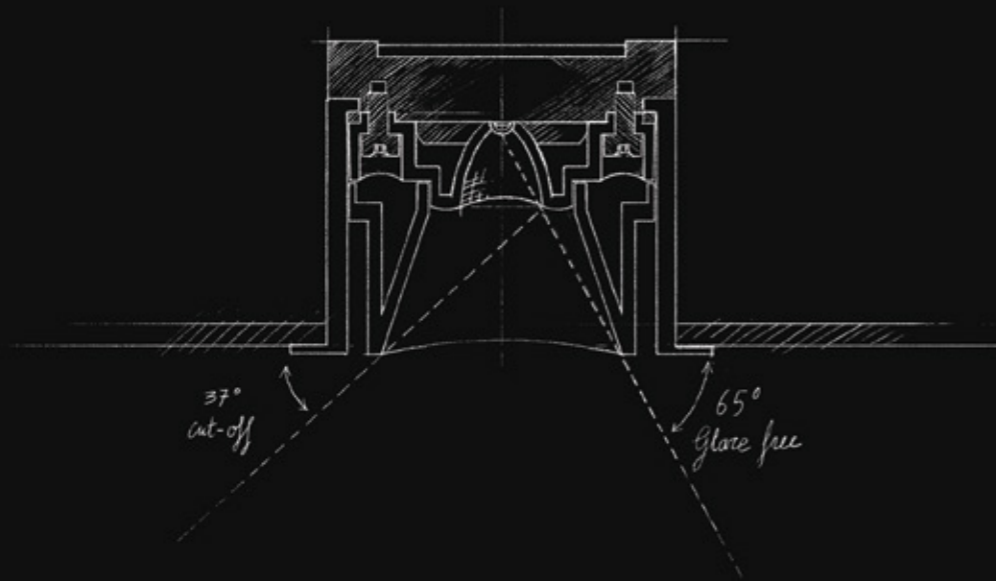

CONFORT VISUAL EN SU MÁXIMA EXPRESIÓN

El secreto de un elevado confort visual y la dificultad de un acceso visual a la fuente de iluminación de Black Foster reside en el alto nivel de apantallamiento logrado por la posición empotrada del LED (recessed), la miniaturización de su reflector y el acabado “negro técnico” de su pantalla.

El ángulo de corte de Black Foster (confort visual absoluto) es de 37° y el ángulo sin deslumbramiento (sin visión directa del LED) es de 65°. Estos valores dan lugar a un índice cercano a UGR 0 en casi cualquier disposición. Por lo tanto, Black Foster cumple fácilmente el requisito UGR<19 (el requisito más estricto contra el deslumbramiento en los códigos técnicos y reglamentos internacionales).

INTEGRACIÓN EN LA ARQUITECTURA

La ocultación del origen de la luz es la característica técnica que más ayuda a la integración de una luminaria en arquitectura, ya que su presencia visual se convierte en significativamente secundaria para el usuario del espacio.

Respecto a Black Foster, el espectador solo podrá tener una visión directa de la fuente de luz si se coloca justo debajo de ella. La percepción de cualquier tipo de alteración de la luz dentro del campo de visión se ha restringido eficazmente a un estrecho rango de ángulos.



MINIATURIZACIÓN Y VANGUARDIA

En el diseño de Black Foster está fielmente representado el espíritu de la arquitectura minimalista moderna y la voluntad de la mejor integración de la luz en el diseño de interiores.

Sus dimensiones reducidas y su discreta presencia conforman la esencia de esta pieza, atesorando en su pequeño volumen una vanguardia técnica de última generación.



ACABADO ORO

Arkoslight incorpora el Oro Metalizado a sus colores y acabados. Este nuevo color aporta una mayor calidad percibida y transmite solidez, lujo, calidez y confort.

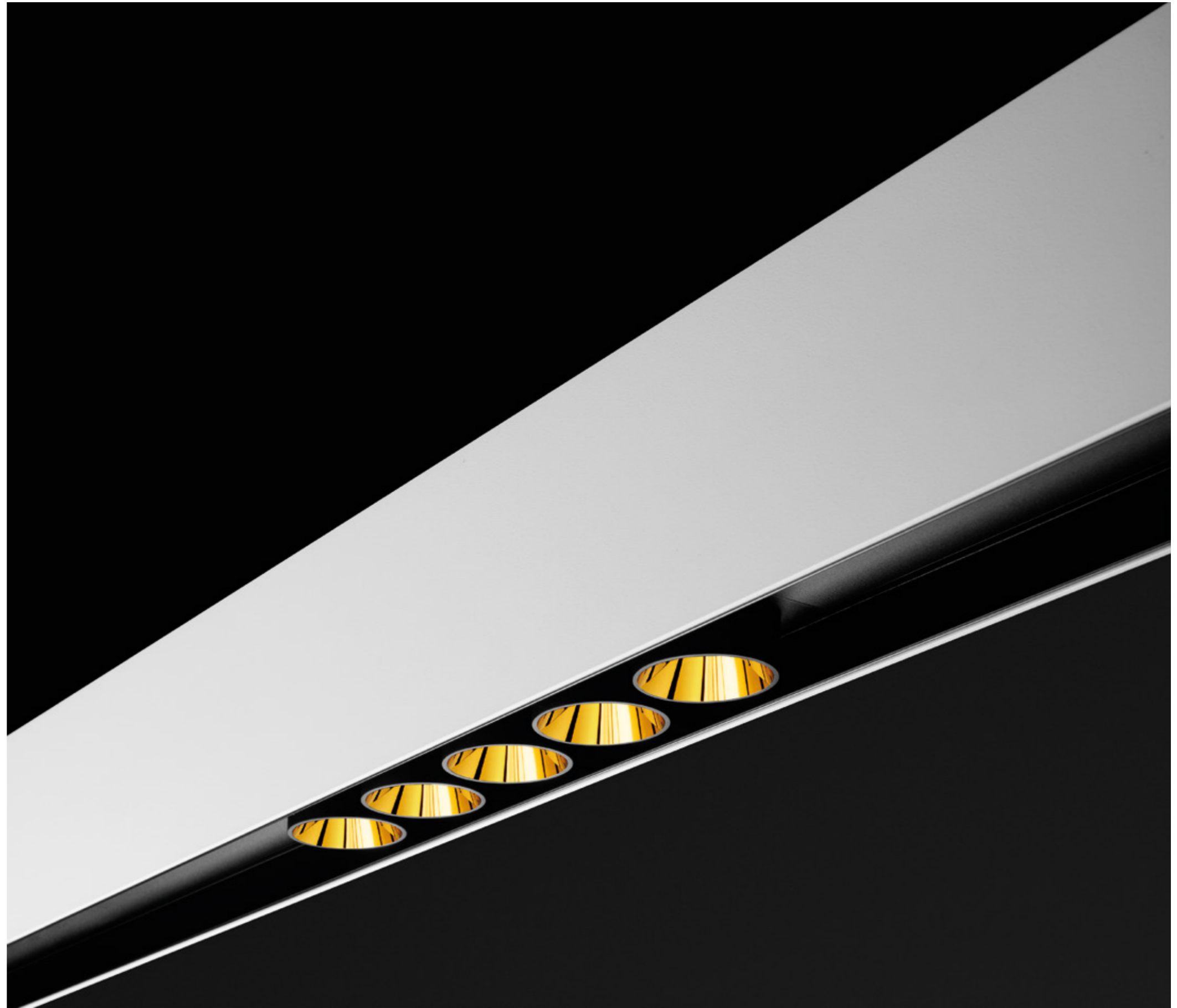



BLACK FOSTER ASYMMETRIC

Black Foster se ofrece con emisión de luz asimétrica en sus variantes 'Recessed', 'Trimless' y 'Custom'.



UNA AMPLIA GAMA DE VERSIONES

BLACK FOSTER

RECESSED

Destaca por su bisel, muy fino y estrecho, que desaparece prácticamente después de ser instalado y genera un efecto visual "trimless".

BLACK FOSTER RECESSED 1



BLACK FOSTER RECESSED 2 & BLACK FOSTER ASYMMETRIC RECESSED 2



BLACK FOSTER RECESSED 3 & BLACK FOSTER ASYMMETRIC RECESSED 3



BLACK FOSTER RECESSED 5 & BLACK FOSTER ASYMMETRIC RECESSED 5



BLACK FOSTER
TRIMLESS

BLACK FOSTER TRIMLESS 1



BLACK FOSTER TRIMLESS 2 & BLACK FOSTER ASYMMETRIC TRIMLESS 2



BLACK FOSTER TRIMLESS 3 & BLACK FOSTER ASYMMETRIC TRIMLESS 3



BLACK FOSTER TRIMLESS 5 & BLACK FOSTER ASYMMETRIC TRIMLESS 5



BLACK FOSTER TRIMLESS 10 & BLACK FOSTER ASYMMETRIC TRIMLESS 10



BLACK FOSTER TRIMLESS 15 & BLACK FOSTER ASYMMETRIC TRIMLESS 10



BLACK FOSTER

MICRO RECESEED

Black Foster Micro es una proeza de ingeniería que traslada el aclamado efecto 'The Invisible Black' a una luminaria hiper-reducida.

Su diminuto tamaño y finísimo marco ofrecen una estética de 'trimless visual' que se une a una presencia casi inapreciable debido a sus dimensiones compactas.

BLACK FOSTER MICRO RECESSED 3



BLACK FOSTER MICRO RECESSED 5



BLACK FOSTER MICRO RECESSED 2 X 2



BLACK FOSTER MICRO RECESSED 3 X 3



BLACK FOSTER

MICRO 24V

Black Foster Micro 24V para Minimal Track, el downlight más compacto con efecto 'The Invisible Black'.

Esta luminaria lineal cuenta con un excelente control del haz de luz cuyos rayos no bañan la luminaria y se encauzan directamente al exterior sin tocar la pantalla. Además, su reducido diseño permite insertar módulos en los sistemas con una absoluta integración.

BLACK FOSTER MICRO 24V 5



BLACK FOSTER

MICRO 48V

BLACK FOSTER MICRO 48V 5



BLACK FOSTER MICRO 48V 10



BLACK FOSTER
SURFACE

BLACK FOSTER SURFACE 1



BLACK FOSTER SURFACE 2



BLACK FOSTER SURFACE 3



BLACK FOSTER SURFACE 5



BLACK FOSTER SURFACE 10



BLACK FOSTER SURFACE 15





BLACK FOSTER SUSPENSION 1200



BLACK FOSTER SUSPENSION 1600



BLACK FOSTER

SUSPENSION —————

El traslado de las virtudes antideslumbramiento de Black Foster a esta versión suspendida convierte a esta luminaria en la solución ideal para iluminar lugares de trabajo. Además, su regulación DIM integrada permite al usuario ajustar de manera individual la cantidad de luz que desea en su plano de trabajo.



DIM ON BOARD

BLACK FOSTER
CUSTOM

Una línea de oscuridad perfecta, de donde emana la luz. Un sistema personalizable que se configura combinando segmentos con emisión de luz y segmentos 'ciegos' que son, visualmente, indistinguibles entre sí. Es el efecto 'Invisible Black'.

Además, el sistema cuenta con 3 modelos de proyectores, que se pueden integrar en su recorrido, para añadir iluminación de acento.



BLACK FOSTER
CUSTOM SURFACE —

Black Foster Custom Surface permite la redistribución de sus módulos combinables una vez se instala el sistema. Los segmentos con emisión de luz y ciegos pueden recolocarse a merced de los cambios en el espacio gracias a la libertad que permite su adaptador.

Además, el sistema Black Foster Custom Surface cuenta con un módulo con proyector Fit 27 para iluminación de acento integrada.



JUMA architects | Susana Ocaña | Photography: Eugeni Pons

BLACK FOSTER
MICRO CUSTOM
SURFACE

Black Foster Micro Custom Surface abre un nuevo paradigma de miniaturización en el sistema lineal y personalizable que integra iluminación con efecto 'The Invisible Black'. Al igual que su hermano mayor, la versión Micro para superficie cuenta con total movilidad y flexibilidad de sus módulos dentro del perfil ya instalado.



BLACK FOSTER
TECHNICAL
SPECIFICATIONS

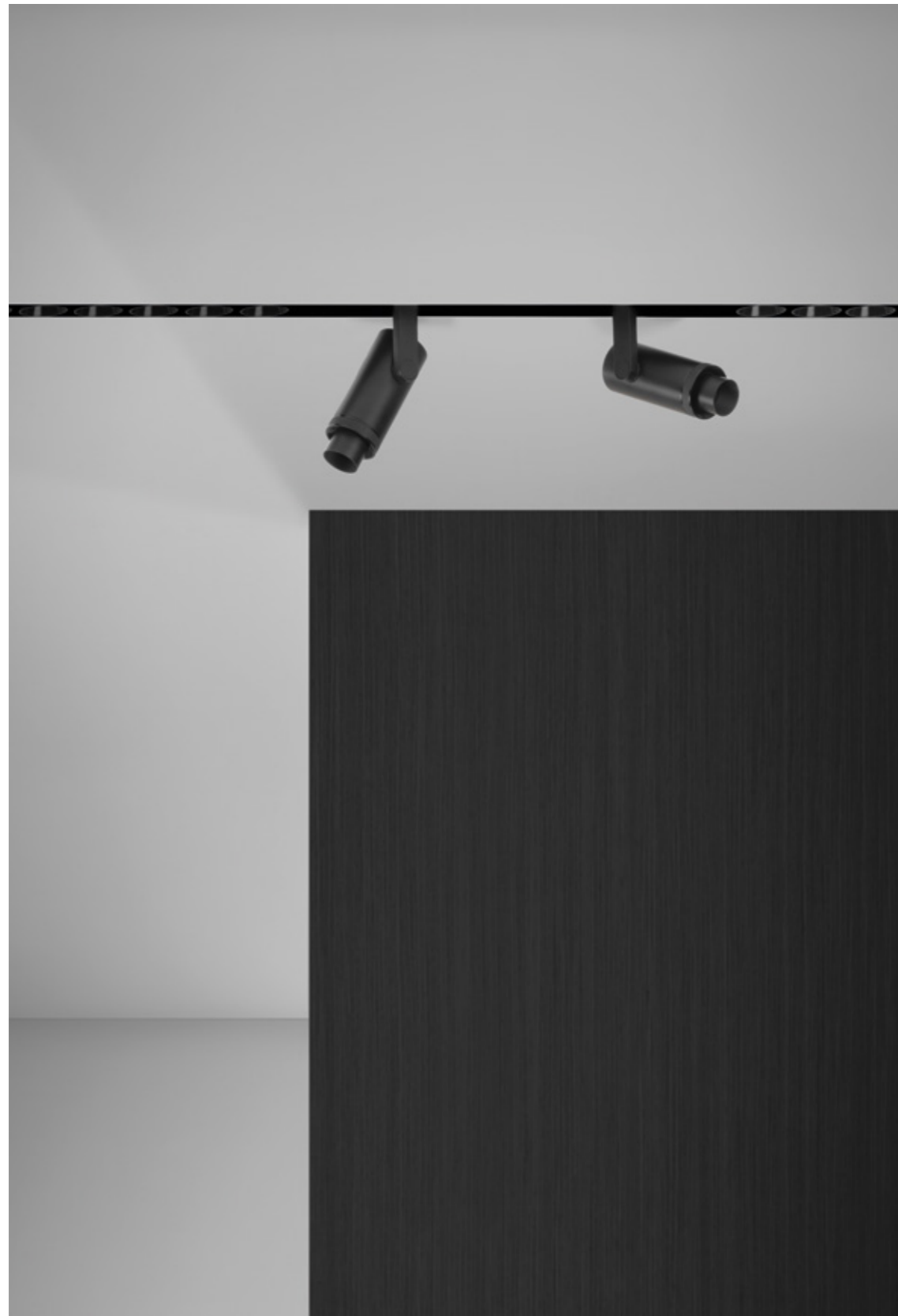

BLACK FOSTER CUSTOM

		P	CCT	I	Flux	L
BLACK FOSTER Custom 2	A317-2- ○ -00- N NMG	4,2W	2700K	700mA	380Lm	87mm
	A317-2- ○ -01- N NMG	4,2W	3000K	700mA	420Lm	87mm
	A317-2- ○ -02- N NMG	4,2W	4000K	700mA	500Lm	87mm
BLACK FOSTER Custom 3	A317-3- ○ -00- N NMG	6,3W	2700K	700mA	570Lm	130mm
	A317-3- ○ -01- N NMG	6,3W	3000K	700mA	630Lm	130mm
	A317-3- ○ -02- N NMG	6,3W	4000K	700mA	750Lm	130mm
BLACK FOSTER Custom 5	A317-4- ○ -00- N NMG	10,5W	2700K	700mA	950Lm	216mm
	A317-4- ○ -01- N NMG	10,5W	3000K	700mA	1050Lm	216mm
	A317-4- ○ -02- N NMG	10,5W	4000K	700mA	1250Lm	216mm
BLACK FOSTER Custom 10	A317-5- ○ -00- N NMG	21W	2700K	700mA	1900Lm	431mm
	A317-5- ○ -01- N NMG	21W	3000K	700mA	2100Lm	431mm
	A317-5- ○ -02- N NMG	21W	4000K	700mA	2500Lm	431mm
BLACK FOSTER Custom 15	A317-6- ○ -00- N NMG	31,5W	2700K	700mA	2850Lm	646mm
	A317-6- ○ -01- N NMG	31,5W	3000K	700mA	3150Lm	646mm
	A317-6- ○ -02- N NMG	31,5W	4000K	700mA	3750Lm	646mm

III IP20 | CRI>90 | L80B10 >60.000h



○	BEAM	LOR
0	38°	92%
1	19°	90%

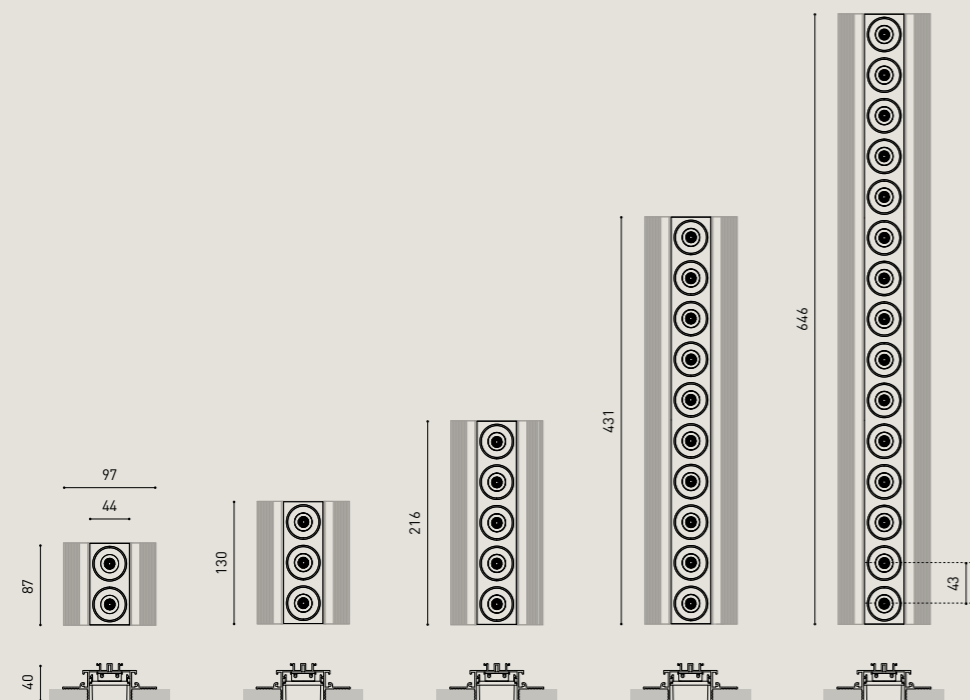

COLOUR | N ■ | NMG ■ | MATERIAL | AL | ABS+PC

PLASTERBOARD CEILING, MANDATORY THICKNESS 12,5mm. RECOMMENDED FOR INSTALLATIONS WHERE THE PROFILE CAN BE INSTALLED BEFORE THE FALSE PLASTERBOARD CEILING.

((())) » PLEASE CONSULT

BLACK FOSTER ASYMMETRIC CUSTOM

		P	CCT	I	Flux	LOR	L
BLACK FOSTER Asymmetric Custom 2	A372-20-00- N	4,2W	2700K	700mA	380Lm	90%	87mm
	A372-20-01- N	4,2W	3000K	700mA	420Lm	90%	87mm
	A372-20-02- N	4,2W	4000K	700mA	500Lm	90%	87mm
BLACK FOSTER Asymmetric Custom 3	A372-30-00- N	6,3W	2700K	700mA	570Lm	90%	130mm
	A372-30-01- N	6,3W	3000K	700mA	630Lm	90%	130mm
	A372-30-02- N	6,3W	4000K	700mA	750Lm	90%	130mm
BLACK FOSTER Asymmetric Custom 5	A372-40-00- N	10,5W	2700K	700mA	950Lm	90%	216mm
	A372-40-01- N	10,5W	3000K	700mA	1050Lm	90%	216mm
	A372-40-02- N	10,5W	4000K	700mA	1250Lm	90%	216mm
BLACK FOSTER Asymmetric Custom 10	A372-50-00- N	21W	2700K	700mA	1900Lm	90%	431mm
	A372-50-01- N	21W	3000K	700mA	2100Lm	90%	431mm
	A372-50-02- N	21W	4000K	700mA	2500Lm	90%	431mm
BLACK FOSTER Asymmetric Custom 15	A372-60-00- N	31,5W	2700K	700mA	2850Lm	90%	646mm
	A372-60-01- N	31,5W	3000K	700mA	3150Lm	90%	646mm
	A372-60-02- N	31,5W	4000K	700mA	3750Lm	90%	646mm

III IP20 | CRI>90 | L80B10 >60.000h



○	BEAM	LOR
0	38°	92%
1	19°	90%

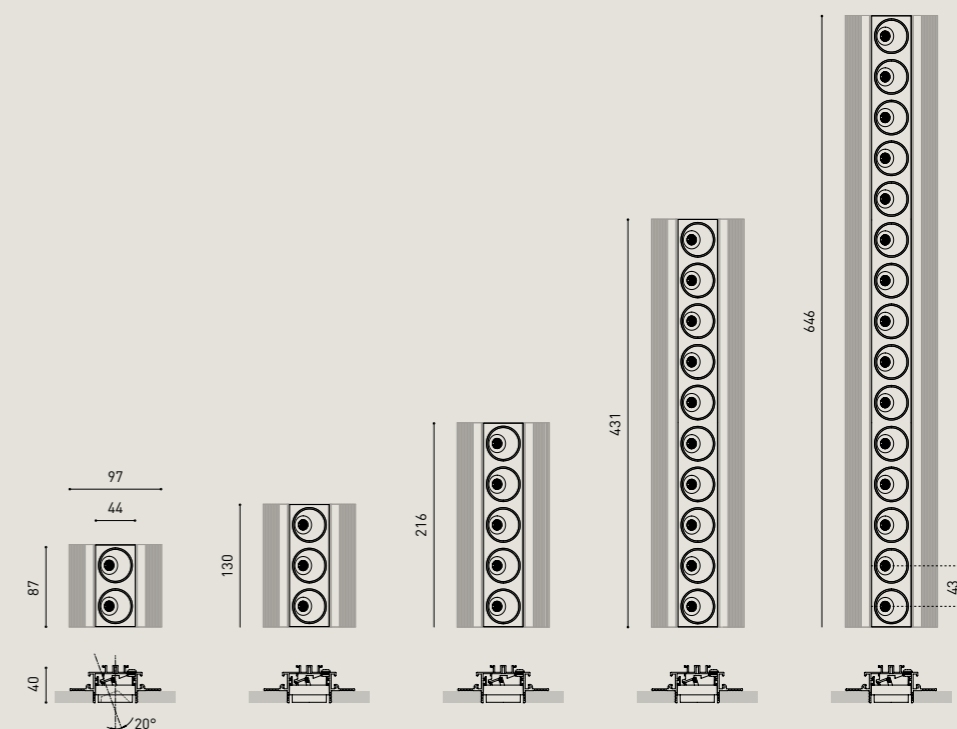

COLOUR | N ■ | MATERIAL | AL | ABS+PC

PLASTERBOARD CEILING, MANDATORY THICKNESS 12,5mm. RECOMMENDED FOR INSTALLATIONS WHERE THE PROFILE CAN BE INSTALLED BEFORE THE FALSE PLASTERBOARD CEILING.

((())) » PLEASE CONSULT



L

BLACK FOSTER Custom	Gap Corner 90°	A317-00-07- N 	200 x 200mm
	Gap 250	A317-00-01- N 	250mm
	Gap 500	A317-00-02- N 	500mm
	Gap 1000	A317-00-03- N 	1000mm
	Gap 2000	A317-00-04- N 	2000mm

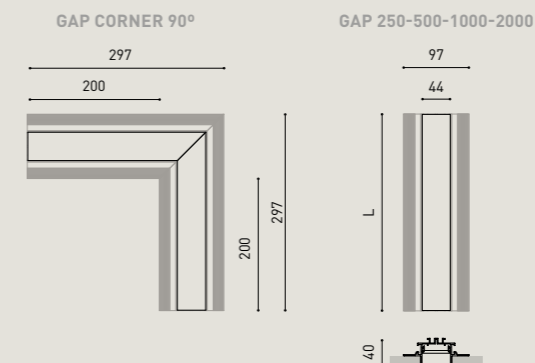

BLACK FOSTER End Caps Kit	A317-00-05- N 	Thickness of each cover=2mm.
----------------------------------	--------------------------	------------------------------

BLACK FOSTER Straight Joiner	A317-00-06	
-------------------------------------	-------------------	--

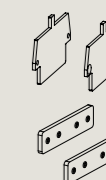

			P	I	D
DRIVER OPTIONS*	NO DIM	0434-01-18	50W	700mA	124 x 79 x 22mm
	DALI PUSH / 1-10V	0433-00-23	50W	700mA	124 x 79 x 22mm

220V~ | DRIVER MUST BE PLACED ON REMOTE | Phase cut please consult
240V~

Connect in series.

MOUNTING ACCESSORIES

BLACK FOSTER Fixation Kit	A219-21-06- B
----------------------------------	--------------------------

BLACK FOSTER Flush Ceiling Kit	A219-22-06- B
---------------------------------------	--------------------------

BLACK FOSTER Track Clamp Kit for M6 ROD	A219-21-21- B
--	--------------------------

BLACK FOSTER Suspension Kit	A219-21-10- B
------------------------------------	--------------------------

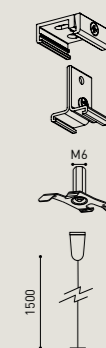

SUGGESTED MOUNTING ACCESSORIES QUANTITIES

Black Foster custom 2, 3, 5: 1 Pcs.
Black Foster custom 10, 15: 2 Pcs.
Gap 250, 500: 1 Pcs.
Gap 1000, 2000: 2 Pcs.

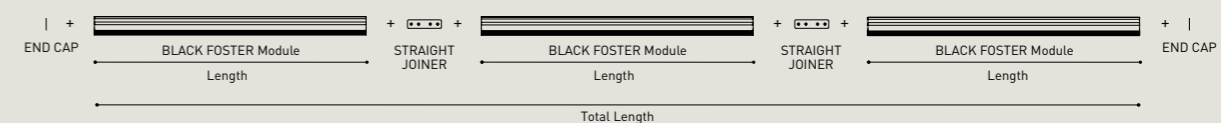

COLOUR | **N** ■ | **B** □ | MATERIAL | AL | ABS+PC |

PLASTERBOARD CEILING, MANDATORY THICKNESS 12,5mm. RECOMMENDED FOR INSTALLATIONS WHERE THE PROFILE CAN BE INSTALLED BEFORE THE FALSE PLASTERBOARD CEILING.

» PLEASE CONSULT

BLACK FOSTER CUSTOM

SIX S

		P	CCT	BEAM	I	Flux	LOR
BLACK FOSTER SIX S	A360-0- Ⓞ -10- WT NT	8,5W	2700K	17°	500mA	1030Lm	86%
	A360-0- Ⓞ -11- WT NT	8,5W	3000K	17°	500mA	1070Lm	86%
	A360-0- Ⓞ -12- WT NT	8,5W	4000K	17°	500mA	1100Lm	86%
	A360-0- Ⓞ -20- WT NT	8,5W	2700K	24°	500mA	1030Lm	84%
	A360-0- Ⓞ -21- WT NT	8,5W	3000K	24°	500mA	1070Lm	84%
	A360-0- Ⓞ -22- WT NT	8,5W	4000K	24°	500mA	1100Lm	84%
	A360-0- Ⓞ -30- WT NT	8,5W	2700K	34°	500mA	1030Lm	89%
	A360-0- Ⓞ -31- WT NT	8,5W	3000K	34°	500mA	1070Lm	89%
	A360-0- Ⓞ -32- WT NT	8,5W	4000K	34°	500mA	1100Lm	89%

220V~
240V~ | IP20 | CRI>90 | L80B10
>60.000h



Ⓞ *OPTIONS

1	No DIM
2	DIM DALI

ACCESSORY

SIX S High Chromatic LED**

NOT SOLD SEPARATELY

» 080

BLACK FOSTER SIX S

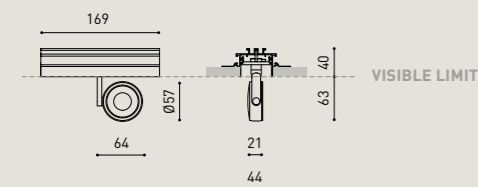

COLOUR | WT RAL 9016 | NT RAL 9005 | MATERIAL | AL | PC | ABS+PC | » 080

** ACCESSORY & COLOURS AFFECTS THE LIGHTING PARAMETERS
PLASTERBOARD CEILING, MANDATORY THICKNESS 12,5mm. RECOMMENDED FOR INSTALLATIONS
WHERE THE PROFILE CAN BE INSTALLED BEFORE THE FALSE PLASTERBOARD CEILING.

& » PLEASE CONSULT

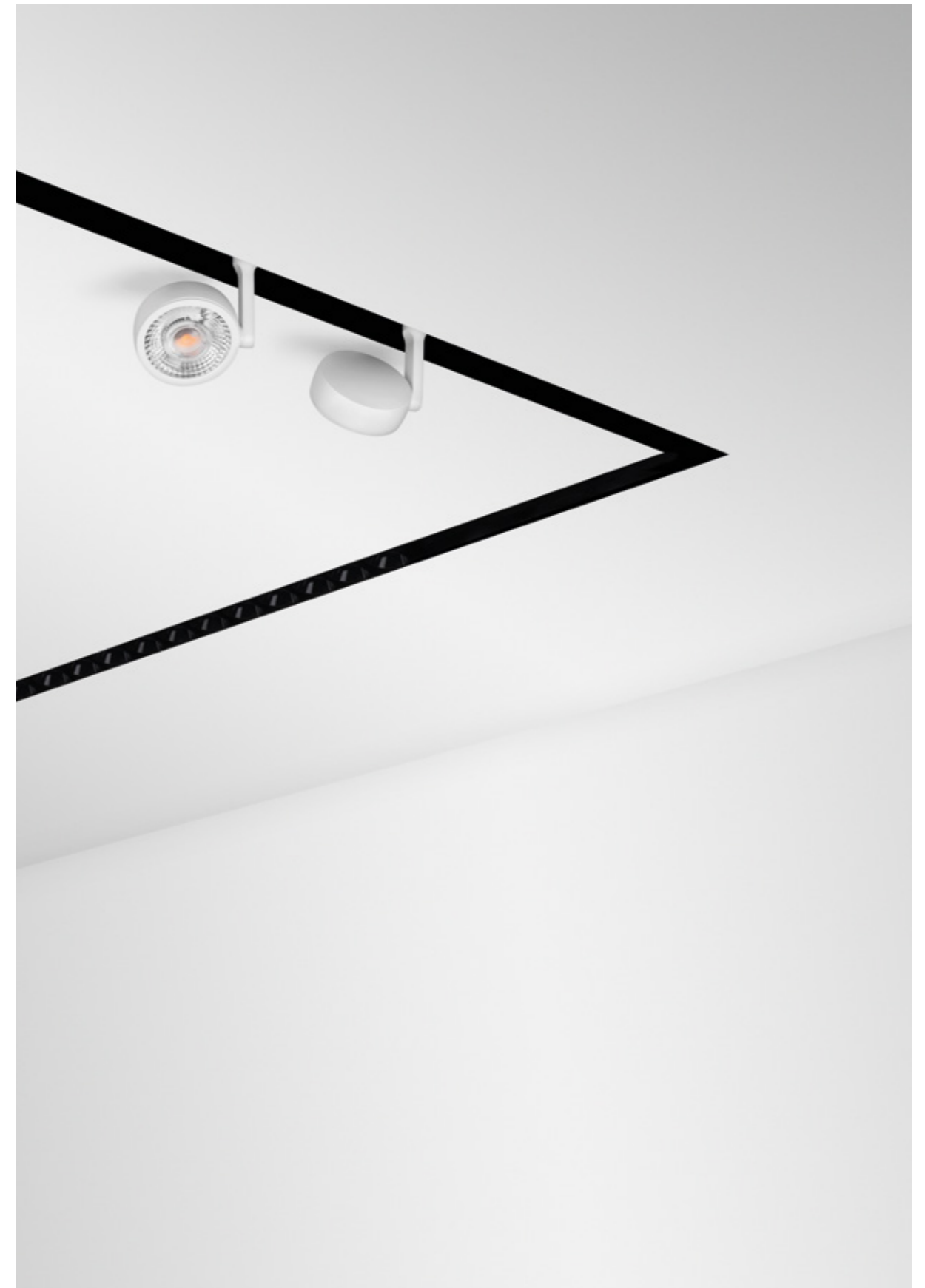

BLACK FOSTER CUSTOM
PLUS MINI

		P	CCT	BEAM	I	Flux	LOR
BLACK FOSTER PLUS Mini	A362-00- -0- WT NT	6,5W	2700K	10°-41°	700mA	630Lm	20-40%
	A362-00- -1- WT NT	6,5W	3000K	10°-41°	700mA	660Lm	20-40%
	A362-00- -2- WT NT	6,5W	4000K	10°-41°	700mA	680Lm	20-40%

220V~ | 240V~ | IP20 | CRI>90 | L80B10 >60.000h



*OPTIONS

1	No DIM
2	DIM DALI

ACCESSORY

PLUS mini High Chromatic LED**

NOT SOLD SEPARATELY



BLACK FOSTER PLUS MINI

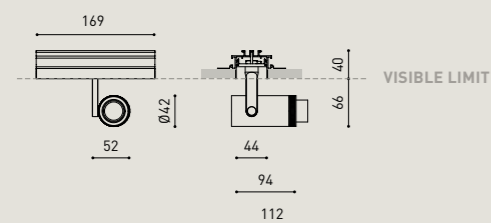

COLOUR | WT RAL 9016 | NT RAL 9005 | MATERIAL | AL | OPTICAL GLASS | ABS+PC | >> 080

** ACCESSORY AFFECTS THE LIGHTING PARAMETERS
PLASTERBOARD CEILING, MANDATORY THICKNESS 12,5mm. RECOMMENDED FOR INSTALLATIONS WHERE THE PROFILE CAN BE INSTALLED BEFORE THE FALSE PLASTERBOARD CEILING.

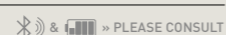

BLACK FOSTER CUSTOM
FIT Ø35

		P	CCT	BEAM	I	Flux	LOR
BLACK FOSTER FIT 35	A363-0- -10- WT NT G	5,5W	2700K	19°	500mA	590Lm	82%
	A363-0- -11- WT NT G	5,5W	3000K	19°	500mA	630Lm	82%
	A363-0- -20- WT NT G	5,5W	2700K	29°	500mA	590Lm	80%
	A363-0- -21- WT NT G	5,5W	3000K	29°	500mA	630Lm	80%
	A363-0- -30- WT NT G	5,5W	2700K	38°	500mA	590Lm	80%
	A363-0- -31- WT NT G	5,5W	3000K	38°	500mA	630Lm	80%

220V~ | 240V~ | IP20 | CRI>90 | L80B10 >60.000h



*OPTIONS

1	No DIM
2	DIM DALI

ACCESSORY

FIT Ø35 Anti-glare Honeycomb Louver ** A345-00-00

NOT SOLD SEPARATELY



BLACK FOSTER FIT Ø35

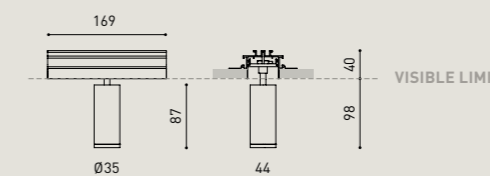

COLOUR | WT RAL 9016 | NT RAL 9005 | G RAL 1036 | MATERIAL | AL | PC | ABS+PC | >> 058

** ACCESSORY AFFECTS THE LIGHTING PARAMETERS
PLASTERBOARD CEILING, MANDATORY THICKNESS 12,5mm. RECOMMENDED FOR INSTALLATIONS WHERE THE PROFILE CAN BE INSTALLED BEFORE THE FALSE PLASTERBOARD CEILING.



BLACK FOSTER CUSTOM
SURFACE

		P	CCT	I	Flux
BLACK FOSTER Custom Surface 3	A453-3- ○ - ○ - ○ -0- N NMG	6,3W	2700K	700mA	570Lm
	A453-3- ○ - ○ - ○ -1- N NMG	6,3W	3000K	700mA	630Lm
	A453-3- ○ - ○ - ○ -2- N NMG	6,3W	4000K	700mA	750Lm
BLACK FOSTER Custom Surface 5	A453-4- ○ - ○ - ○ -0- N NMG	10,5W	2700K	700mA	950Lm
	A453-4- ○ - ○ - ○ -1- N NMG	10,5W	3000K	700mA	1050Lm
	A453-4- ○ - ○ - ○ -2- N NMG	10,5W	4000K	700mA	1250Lm
BLACK FOSTER Custom Surface 10	A453-5- ○ - ○ - ○ -0- N NMG	21W	2700K	700mA	1900Lm
	A453-5- ○ - ○ - ○ -1- N NMG	21W	3000K	700mA	2100Lm
	A453-5- ○ - ○ - ○ -2- N NMG	21W	4000K	700mA	2500Lm

48 V | III | IP20 | CRI>90 | L80B10 >60.000h



○	BEAM	LOR
0	38°	92%
1	19°	90%

⊗	*OPTIONS
1	No DIM
2	DIM DALI

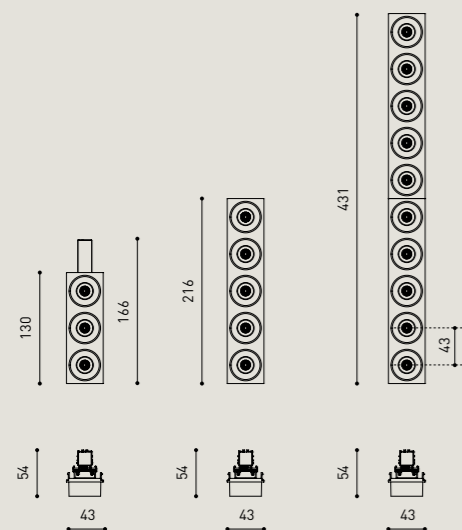

COLOUR | N ■ | NMG ■ | MATERIAL | AL | ABS+PC

☎ → PLEASE CONSULT



		P	CCT	I	Flux
BLACK FOSTER Custom Surface FIT 27	A454-0- - -0- WT NT G	5,5W	2700K	500mA	550Lm
	A454-0- - -1- WT NT G	5,5W	3000K	500mA	600Lm
	A454-0- - -2- WT NT G	5,5W	4000K	500mA	640Lm

48V | IP20 | CRI>90 | L80B10 >60.000h



	BEAM	LOR
1	22°	84%
2	37°	82%
3	46°	81%

*OPTIONS	
1	No DIM
2	DIM DALI

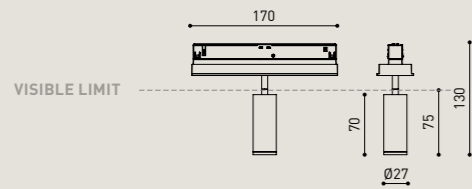

COLOUR | WT | NT | G | MATERIAL | AL | PC |

» PLEASE CONSULT

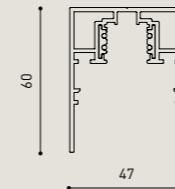

BLACK FOSTER Custom Surface 1m	A452-01-00- NT WT
BLACK FOSTER Custom Surface 2m	A452-02-00- NT WT
BLACK FOSTER Custom Surface 3m	A452-03-00- NT WT



BLACK FOSTER Custom Surface L-Joint	A452-04-00- NT WT
BLACK FOSTER Custom Surface T-Joint	A452-05-00- NT WT
BLACK FOSTER Custom Surface X-Joint	A452-06-00- NT WT



L

BLACK FOSTER Custom Surface Gap 250	A452-00-01- N	250mm
BLACK FOSTER Custom Surface Gap 500	A452-00-02- N	500mm

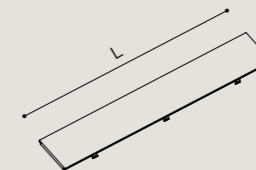

DROP VOLTAGE TABLE

POWER (W)	CABLE SECTION (mm ²)	CABLE LENGTH (m)			
		5	10	20	30
100	0,75	50	50	X	X
	1,5	50	50	40	25
150	0,75	40	15	X	X
	1,5	50	40	20	X

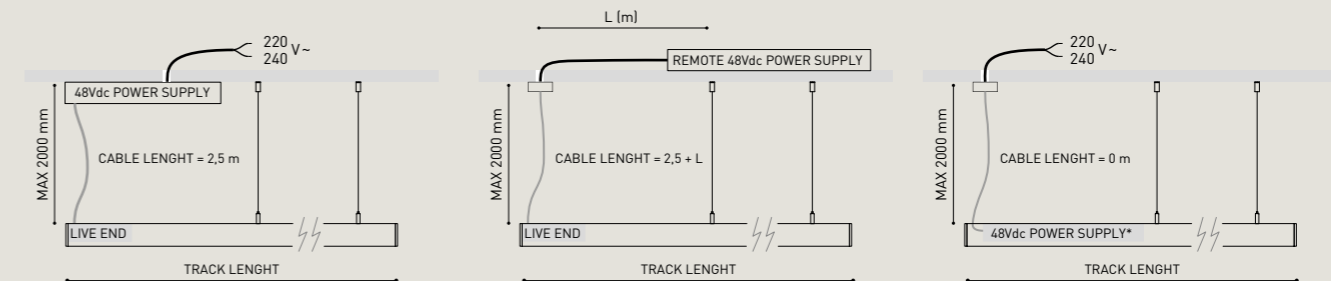

COLOUR | NT | WT | N |

» PLEASE CONSULT

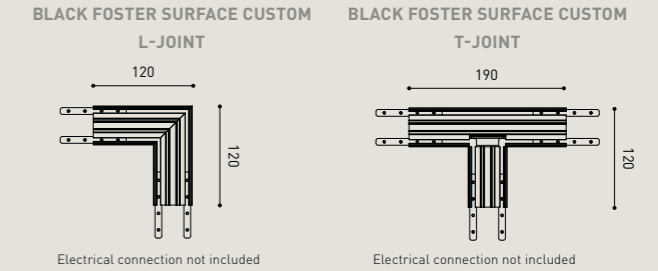

BLACK FOSTER SURFACE CUSTOM

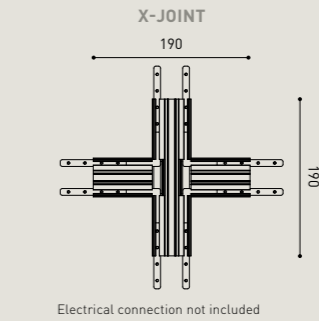

		P	V	D (A x B x C)
Constant Voltage LED POWER SUPPLY	0434-01-61*	100W	48V	198 x 16 x 19mm
	0434-01-62	150W	48V	350 x 30 x 18mm

220V~ | 240V~ | *To be installed inside the track.

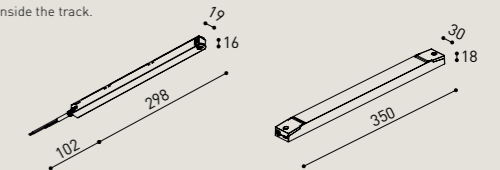

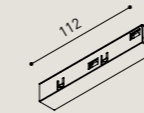

Live-End Connector

A338-00-01- | N |

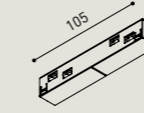

Central Connector

A338-00-02- | N |

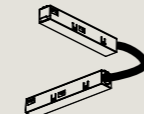

L-Joint Connector

A338-00-12- | N |

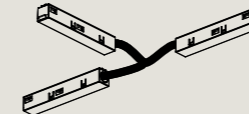

T-Joint Connector

A450-00-07- | N |

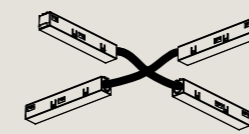

X-Joint Connector

A450-00-08- | N |

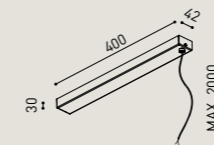

Wired Power Supply Case 48V

A338-00-25- | NT | WT | 150W NO DIM

A338-00-26- | NT | WT | 150W DIM

220V~
240V~
INCL



BLACK FOSTER Custom Surface

Suspension Kit (2 units)

A450-00-09- | NT | WT |

Suggested mounting accessories quantities:

1000mm - 2 Pcs.

2000mm - 2 Pcs.

3000mm - 3 Pcs.

MAINS TRIMLESS

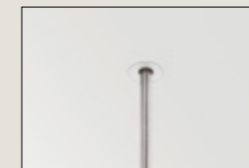

MAINS THICK TRIMLESS

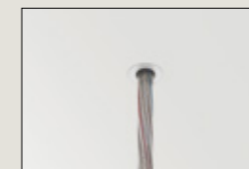

STEEL CABLE TRIMLESS

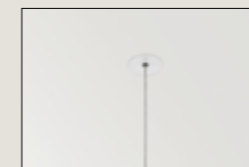

WIRE TRIMLESS ACCESSORIES

FEED

Mains Trimless*

A023-00-01- | W | N |

NO DIM

Mains Thick Trimless*

A023-00-02- | W | N |

DIM

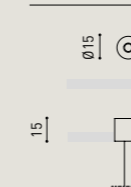

REMOTE INCL Ø20

FASTENING

Steel Cable Trimless*

A023-00-05- | W | N |

Ø15 INCL Ø20

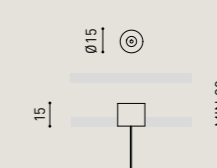

COLOUR | N ■ | W □ | NT ■ | WT □ |

* As many pieces as needed ACCORDING to your product



BLACK FOSTER Custom Surface

End A452-00-03- | N | W |



BLACK FOSTER Custom Surface

End Feed A452-00-04- | N | W |

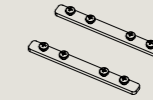

BLACK FOSTER Custom Surface

Straight Joiner A452-00-05

SUSPENSION COMPONENTS

Wired Power Supply Case 48V

A338-00-25- | NT | WT | 150W NO DIM

A338-00-26- | NT | WT | 150W DIM

220V~
240V~
INCL

BLACK FOSTER Custom Surface

Suspension Kit (2 units)

A450-00-09- | NT | WT |

Suggested mounting accessories quantities:

1000mm - 2 Pcs.

2000mm - 2 Pcs.

3000mm - 3 Pcs.



Suspension Feed Kit

A338-00-16- | N | W | NO DIM

A338-00-17- | N | W | DIM

For remote power supply

A338-00-27- | N | W | NO DIM

A338-00-28- | N | W | DIM

For power supply inside the track

BLACK FOSTER CUSTOM
MICRO SURFACE



		P	CCT	I	Flux	LOR
BLACK FOSTER Micro Custom Surface 3	A451-10- ① -0- N	4,2W	2700K	500mA	465Lm	87%
	A451-10- ① -1- N	4,2W	3000K	500mA	480Lm	87%
	A451-10- ① -2- N	4,2W	4000K	500mA	510Lm	87%
BLACK FOSTER Micro Custom Surface 5	A451-20- ① -0- N	7W	2700K	500mA	775Lm	87%
	A451-20- ① -1- N	7W	3000K	500mA	800Lm	87%
	A451-20- ① -2- N	7W	4000K	500mA	850Lm	87%
BLACK FOSTER Micro Custom Surface 10	A451-50- ① -0- N	14W	2700K	500mA	1550Lm	87%
	A451-50- ① -1- N	14W	3000K	500mA	1600Lm	87%
	A451-50- ① -2- N	14W	4000K	500mA	1700Lm	87%

48 V | IP20 | CRI>90 | L80B10 >60.000h

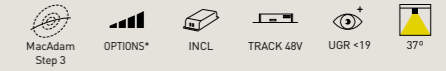

① *OPTIONS

1	No DIM
2	DIM DALI

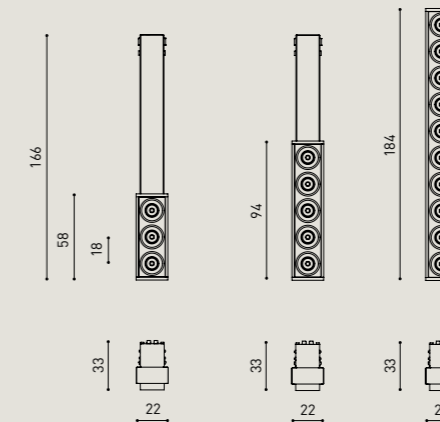

COLOUR | N ■ | MATERIAL | AL | ABS+PC

«(»» PLEASE CONSULT

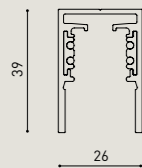

BLACK FOSTER Micro Custom Surface 1m	A450-01-00-	NT	WT
BLACK FOSTER Micro Custom Surface 2m	A450-02-00-	NT	WT
BLACK FOSTER Micro Custom Surface 3m	A450-03-00-	NT	WT



BLACK FOSTER Micro Custom Surface L-Joint	A450-04-00-	NT	WT
BLACK FOSTER Micro Custom Surface T-Joint	A450-05-00-	NT	WT
BLACK FOSTER Micro Custom Surface X-Joint	A450-06-00-	NT	WT



L

BLACK FOSTER Micro Custom Surface Gap 250	A450-01-00-	N	250mm
BLACK FOSTER Micro Custom Surface Gap 500	A450-02-00-	N	500mm
BLACK FOSTER Micro Custom Surface Gap 1000	A450-02-00-	N	1000mm

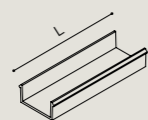

BLACK FOSTER MICRO SURFACE CUSTOM L-JOINT

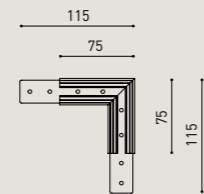

Electrical connection not included

BLACK FOSTER MICRO SURFACE CUSTOM T-JOINT

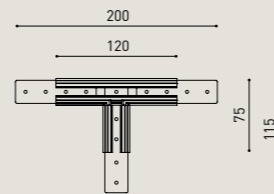

Electrical connection not included

BLACK FOSTER MICRO SURFACE CUSTOM X-JOINT

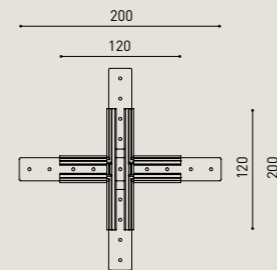

Electrical connection not included

		P	V	D (A x B x C)
Constant Voltage LED POWER SUPPLY	0434-01-61*	100W	48V	198 x 16 x 19mm
	0434-01-62	150W	48V	350 x 30 x 18mm

220V~
240V~

*To be installed inside the track.

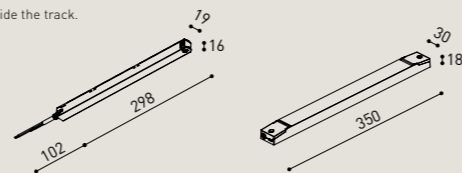

DROP VOLTAGE TABLE

POWER [W]	CABLE SECTION [mm ²]	CABLE LENGTH (m)			
		5	10	20	30
100	0,75	50	50	X	X
	1,5	50	50	40	25
150	0,75	40	15	X	X
	1,5	50	40	20	X

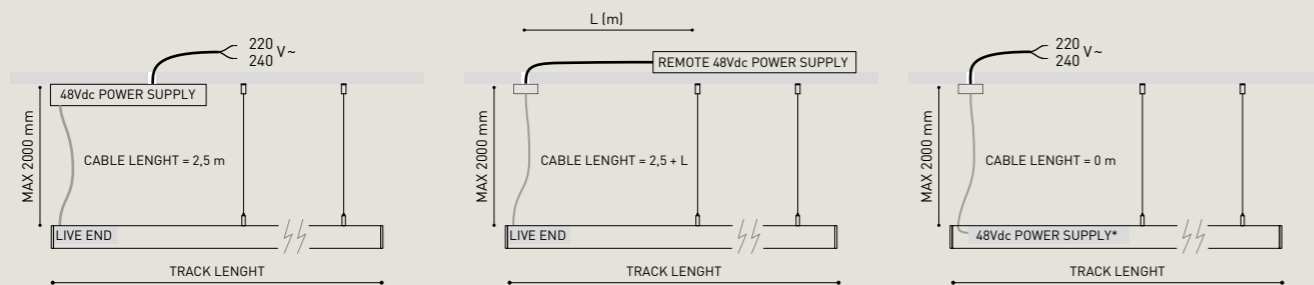

COLOUR | NT ■ | WT □ | N ■ |

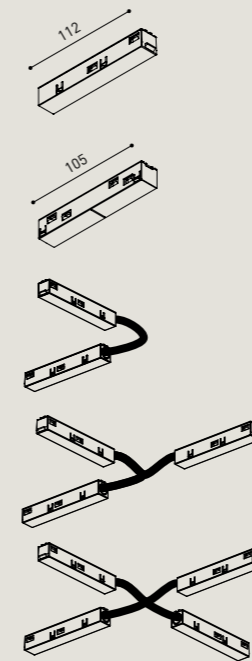

Live-End Connector	A338-00-01-	N
--------------------	-------------	---

Central Connector	A338-00-02-	N
-------------------	-------------	---

L-Joint Connector	A338-00-12-	N
-------------------	-------------	---

T-Joint Connector	A450-00-07-	N
-------------------	-------------	---

X-Joint Connector	A450-00-08-	N
-------------------	-------------	---



BLACK FOSTER Micro Custom Surface	A450-00-04-	N	W
-----------------------------------	-------------	---	---

BLACK FOSTER Micro Custom Surface	A450-00-05-	N	W
-----------------------------------	-------------	---	---

BLACK FOSTER Micro Custom Surface	A450-00-06		
-----------------------------------	------------	--	--

SUSPENSION COMPONENTS

Wired Power Supply Case 48V

A338-00-25-	NT	WT	150W	NO DIM
A338-00-26-	NT	WT	150W	DIM

220V~
240V~
INCL



Suspension Feed Kit

A338-00-16-	N	W	NO DIM
A338-00-17-	N	W	DIM

For remote power supply

A338-00-27-	N	W	NO DIM
-------------	---	---	--------

A338-00-28-	N	W	DIM
-------------	---	---	-----

For power supply inside the track

BLACK FOSTER Micro Custom Surface

Suspension Kit (2 units)

A450-00-09-	NT	WT
-------------	----	----

Suggested mounting accessories quantities:
1000mm - 2 Pcs.
2000mm - 2 Pcs.
3000mm - 3 Pcs.

MAINS TRIMLESS

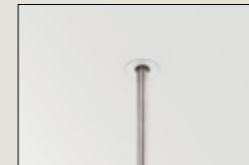

MAINS THICK TRIMLESS

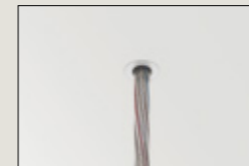

STEEL CABLE TRIMLESS

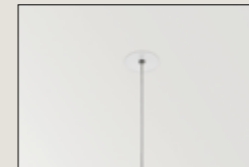

WIRE TRIMLESS ACCESSORIES

FEED

Mains Trimless*

A023-00-01-	W	N	NO DIM
-------------	---	---	--------

Mains Thick Trimless*

A023-00-02-	W	N	DIM
-------------	---	---	-----

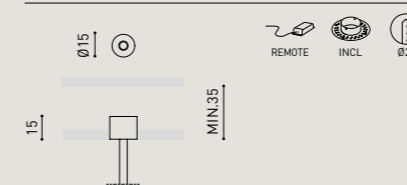

FASTENING

Steel Cable Trimless*

A023-00-05-	W	N
-------------	---	---

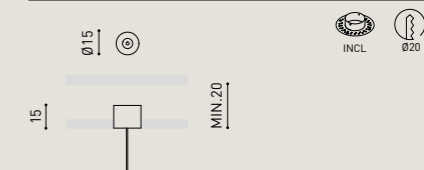

COLOUR | N ■ | W □ | NT ■ | WT □ |

* As many pieces as needed ACCORDING to your product

((())) » PLEASE CONSULT

BLACK FOSTER
RECESSED

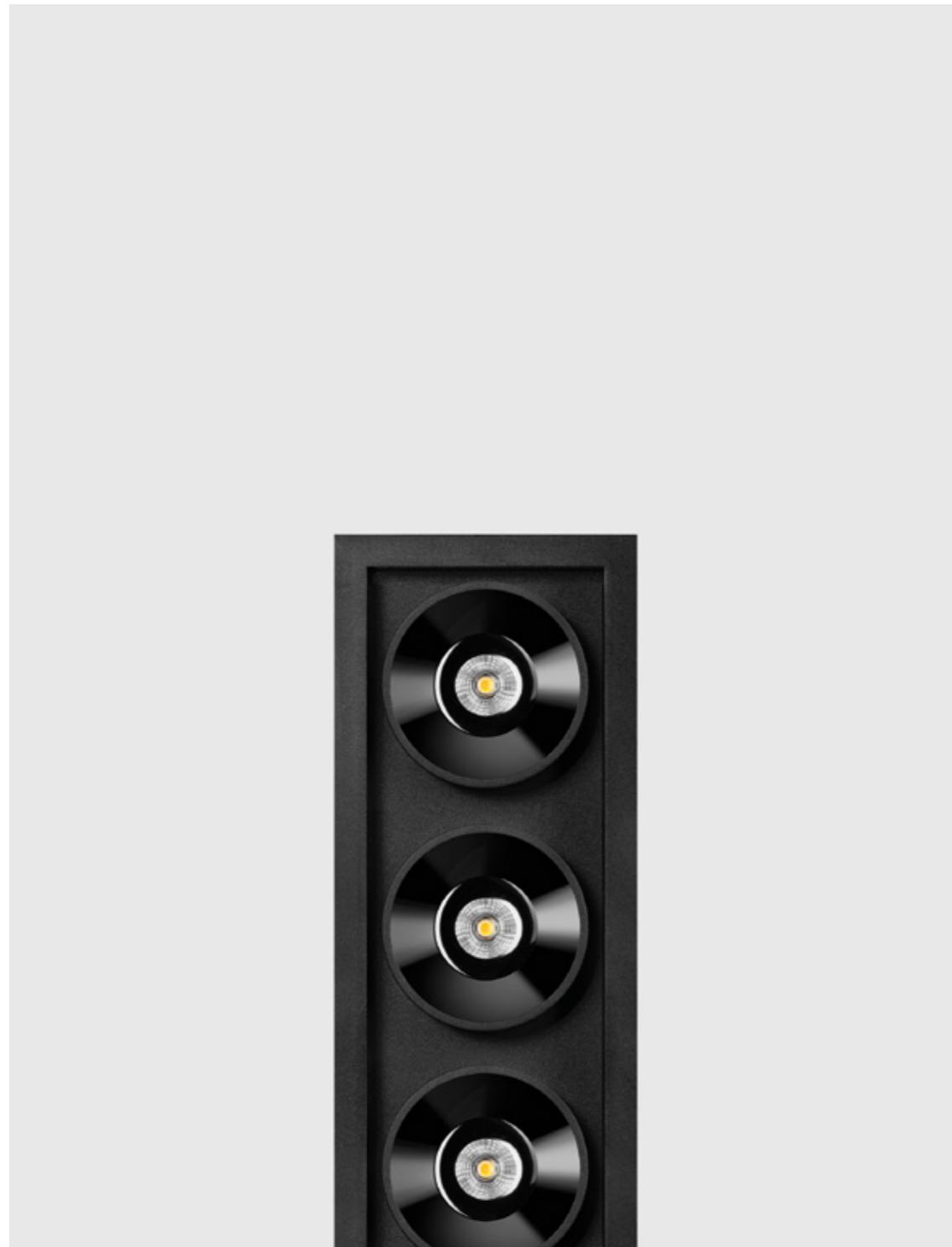

○	BEAM	LOR
0	38°	92%
1	19°	90%

⊞	*OPTIONS
1	No DIM
2	DIM Push
4	DIM DALI

DIM PHASE CUT PLEASE CONSULT

		P	CCT	I	Flux	
BLACK FOSTER Recessed 1	A319-1- ○ -10-	N WN NMG	2,1W	2700K	700mA	190Lm
	A319-1- ○ -11-	N WN NMG	2,1W	3000K	700mA	210Lm
	A319-1- ○ -12-	N WN NMG	2,1W	4000K	700mA	250Lm
	A319-1- ○ -40-	N WN NMG	2,1W	2700K	700mA	190Lm
	A319-1- ○ -41-	N WN NMG	2,1W	3000K	700mA	210Lm
	A319-1- ○ -42-	N WN NMG	2,1W	4000K	700mA	250Lm

220 V~ | 240 V~ | IP20 | CRI>90 | L80B10 > 60.000 h

MacAdam Step 3 | OPTIONS* | INCL | 50 X 50 | UGR <19 | 38° / 19°

		P	CCT	I	Flux	
BLACK FOSTER Recessed 2	A319-2- ○ -0-	N WN NMG	4,2W	2700K	700mA	380Lm
	A319-2- ○ -1-	N WN NMG	4,2W	3000K	700mA	420Lm
	A319-2- ○ -2-	N WN NMG	4,2W	4000K	700mA	500Lm

220 V~ | 240 V~ | IP20 | CRI>90 | L80B10 > 60.000 h

MacAdam Step 3 | OPTIONS* | INCL | 50 X 93 | UGR <19 | 38° / 19°

		P	CCT	I	Flux	
BLACK FOSTER Recessed 3	A319-3- ○ -0-	N WN NMG	6,3W	2700K	700mA	570Lm
	A319-3- ○ -1-	N WN NMG	6,3W	3000K	700mA	630Lm
	A319-3- ○ -2-	N WN NMG	6,3W	4000K	700mA	750Lm

220 V~ | 240 V~ | IP20 | CRI>90 | L80B10 > 60.000 h

MacAdam Step 3 | OPTIONS* | INCL | 50 X 136 | UGR <19 | 38° / 19°

		P	CCT	I	Flux	
BLACK FOSTER Recessed 5	A319-4- ○ -0-	N WN NMG	10,5W	2700K	700mA	950Lm
	A319-4- ○ -1-	N WN NMG	10,5W	3000K	700mA	1050Lm
	A319-4- ○ -2-	N WN NMG	10,5W	4000K	700mA	1250Lm

220 V~ | 240 V~ | IP20 | CRI>90 | L80B10 > 60.000 h

MacAdam Step 3 | OPTIONS* | INCL | 50 X 222 | UGR <19 | 38° / 19°

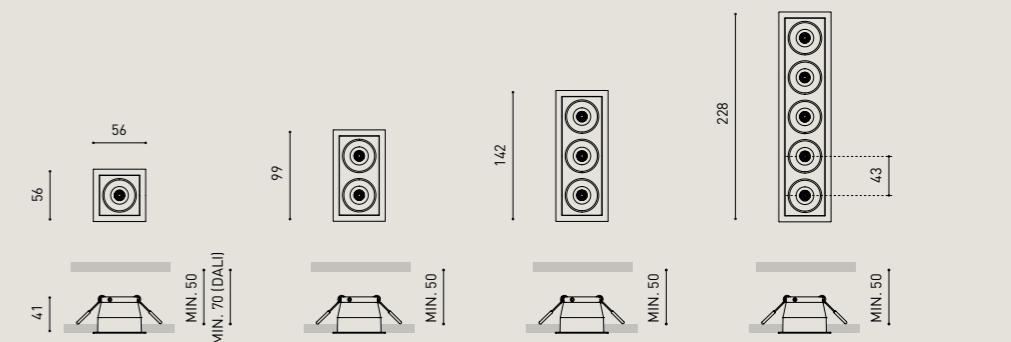

COLOUR | N ■ | WN ■ | NMG ■ | MATERIAL | AL | ABS+PC |

☎ & 📄 » PLEASE CONSULT

BLACK FOSTER ASYMMETRIC

RECESSED

		P	CCT	I	Flux	LOR
BLACK FOSTER Asymmetric Recessed 2	A374-20- ① -0- N WN	4,2W	2700K	700mA	380Lm	90%
	A374-20- ② -1- N WN	4,2W	3000K	700mA	420Lm	90%
	A374-20- ④ -2- N WN	4,2W	4000K	700mA	500Lm	90%

220V~ | 240V~ | IP20 | CRI>90 | L80B10 >60.000h



		P	CCT	I	Flux	LOR
BLACK FOSTER Asymmetric Recessed 3	A374-30- ① -0- N WN	6,3W	2700K	700mA	570Lm	90%
	A374-30- ② -1- N WN	6,3W	3000K	700mA	630Lm	90%
	A374-30- ④ -2- N WN	6,3W	4000K	700mA	750Lm	90%

220V~ | 240V~ | IP20 | CRI>90 | L80B10 >60.000h



		P	CCT	I	Flux	LOR
BLACK FOSTER Asymmetric Recessed 5	A374-40- ① -0- N WN	10,5W	2700K	700mA	950Lm	90%
	A374-40- ② -1- N WN	10,5W	3000K	700mA	1050Lm	90%
	A374-40- ④ -2- N WN	10,5W	4000K	700mA	1250Lm	90%

220V~ | 240V~ | IP20 | CRI>90 | L80B10 >60.000h

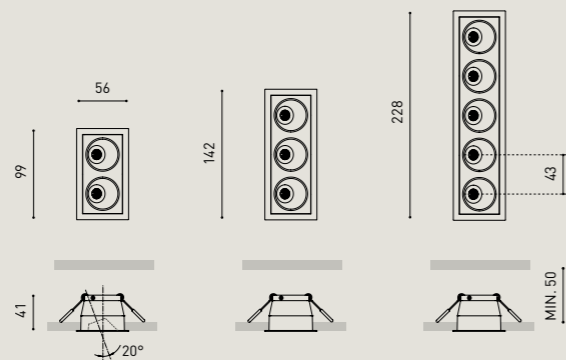

① *OPTIONS

1	No DIM
2	DIM Push
4	DIM DALI

DIM PHASE CUT PLEASE CONSULT

COLOUR | N ■ | WN ■ | MATERIAL | AL | ABS+PC

Ⓢ & Ⓜ » PLEASE CONSULT



BLACK FOSTER TRIMLESS

		P	CCT	I	Flux
BLACK FOSTER Trimless 1	A318-1- ○ -10- N NMG	2,1W	2700K	700mA	190Lm
	NO DIM A318-1- ○ -11- N NMG	2,1W	3000K	700mA	210Lm
	A318-1- ○ -12- N NMG	2,1W	4000K	700mA	250Lm
	A318-1- ○ -40- N NMG	2,1W	2700K	700mA	190Lm
	DALI A318-1- ○ -41- N NMG	2,1W	3000K	700mA	210Lm
	A318-1- ○ -42- N NMG	2,1W	4000K	700mA	250Lm

220 V~ | IP20 | CRI>90 | L80B10 >60.000h



		P	CCT	I	Flux
BLACK FOSTER Trimless 2	A318-2- ○ - 0- N NMG	4,2W	2700K	700mA	380Lm
	A318-2- ○ - 0- -1- N NMG	4,2W	3000K	700mA	420Lm
	A318-2- ○ - 0- -2- N NMG	4,2W	4000K	700mA	500Lm

220 V~ | IP20 | CRI>90 | L80B10 >60.000h



		P	CCT	I	Flux
BLACK FOSTER Trimless 3	A318-3- ○ - 0- N NMG	6,3W	2700K	700mA	570Lm
	A318-3- ○ - 0- -1- N NMG	6,3W	3000K	700mA	630Lm
	A318-3- ○ - 0- -2- N NMG	6,3W	4000K	700mA	750Lm

220 V~ | IP20 | CRI>90 | L80B10 >60.000h



		P	CCT	I	Flux
BLACK FOSTER Trimless 5	A318-4- ○ - 0- N NMG	10,5W	2700K	700mA	950Lm
	A318-4- ○ - 0- -1- N NMG	10,5W	3000K	700mA	1050Lm
	A318-4- ○ - 0- -2- N NMG	10,5W	4000K	700mA	1250Lm

220 V~ | IP20 | CRI>90 | L80B10 >60.000h



○	BEAM	LOR
0	38°	92%
1	19°	90%

Ⓞ	*OPTIONS
1	No DIM
2	DIM Push
4	DIM DALI

DIM PHASE CUT PLEASE CONSULT

COLOUR | N ■ | NMG ■■ | MATERIAL | AL | ABS+PC |

PLASTERBOARD CEILING, MANDATORY THICKNESS 12,5mm. RECOMMENDED FOR INSTALLATIONS WHERE THE PROFILE CAN BE INSTALLED BEFORE THE FALSE PLASTERBOARD CEILING.

Ⓞ & ■■ » PLEASE CONSULT

		P	CCT	I	Flux
BLACK FOSTER Trimless 10	A318-5- ○ - 0- N NMG	21W	2700K	700mA	1900Lm
	A318-5- ○ - 0- -1- N NMG	21W	3000K	700mA	2100Lm
	A318-5- ○ - 0- -2- N NMG	21W	4000K	700mA	2500Lm

220 V~ | IP20 | CRI>90 | L80B10 >60.000h

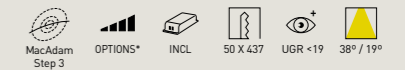

		P	CCT	I	Flux
BLACK FOSTER Trimless 15	A318-6- ○ - 0- N NMG	31,5W	2700K	700mA	2850Lm
	A318-6- ○ - 0- -1- N NMG	31,5W	3000K	700mA	3150Lm
	A318-6- ○ - 0- -2- N NMG	31,5W	4000K	700mA	3750Lm

220 V~ | IP20 | CRI>90 | L80B10 >60.000h

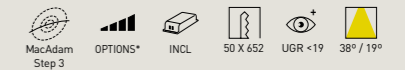

○	BEAM	LOR
0	38°	92%
1	19°	90%

Ⓞ	*OPTIONS
1	No DIM
2	DIM Push
4	DIM DALI

DIM PHASE CUT PLEASE CONSULT

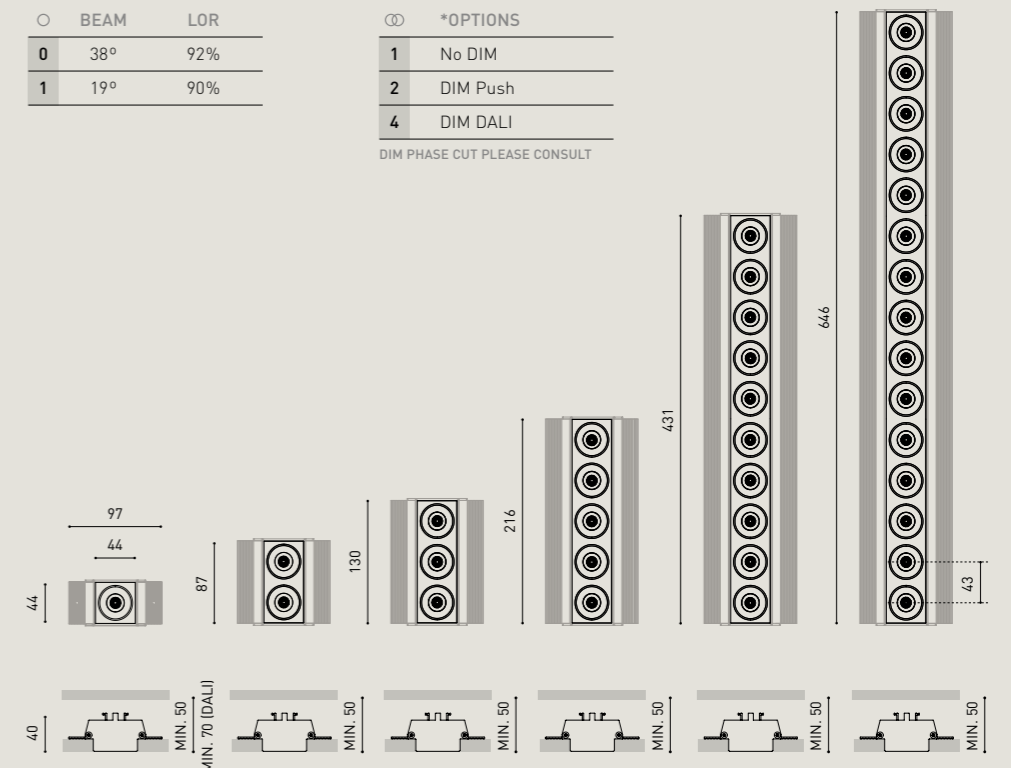

COLOUR | N ■ | NMG ■■ | MATERIAL | AL | ABS+PC |

PLASTERBOARD CEILING, MANDATORY THICKNESS 12,5mm. RECOMMENDED FOR INSTALLATIONS WHERE THE PROFILE CAN BE INSTALLED BEFORE THE FALSE PLASTERBOARD CEILING.

Ⓞ & ■■ » PLEASE CONSULT

BLACK FOSTER ASYMMETRIC

TRIMLESS

		P	CCT	I	Flux	LOR
BLACK FOSTER Asymmetric Trimless 2	A373-20- ① -0- N	4,2W	2700K	700mA	380Lm	90%
	A373-20- ① -1- N	4,2W	3000K	700mA	420Lm	90%
	A373-20- ① -2- N	4,2W	4000K	700mA	500Lm	90%

220V~ | 240V~ | IP20 | CRI>90 | L80B10 >60.000h



		P	CCT	I	Flux	LOR
BLACK FOSTER Asymmetric Trimless 3	A373-30- ① -0- N	6,3W	2700K	700mA	570Lm	90%
	A373-30- ① -1- N	6,3W	3000K	700mA	630Lm	90%
	A373-30- ① -2- N	6,3W	4000K	700mA	750Lm	90%

220V~ | 240V~ | IP20 | CRI>90 | L80B10 >60.000h



		P	CCT	I	Flux	LOR
BLACK FOSTER Asymmetric Trimless 5	A373-40- ① -0- N	10,5W	2700K	700mA	950Lm	90%
	A373-40- ① -1- N	10,5W	3000K	700mA	1050Lm	90%
	A373-40- ① -2- N	10,5W	4000K	700mA	1250Lm	90%

220V~ | 240V~ | IP20 | CRI>90 | L80B10 >60.000h



① *OPTIONS

1	No DIM
2	DIM Push
4	DIM DALI

DIM PHASE CUT PLEASE CONSULT

COLOUR | N ■ | MATERIAL | AL | ABS+PC |

PLASTERBOARD CEILING, MANDATORY THICKNESS 12,5mm. RECOMMENDED FOR INSTALLATIONS WHERE THE PROFILE CAN BE INSTALLED BEFORE THE FALSE PLASTERBOARD CEILING.

Ⓢ & Ⓢ » PLEASE CONSULT

		P	CCT	I	Flux	LOR
BLACK FOSTER Asymmetric Trimless 10	A373-50- ① -0- N	21W	2700K	700mA	1900Lm	90%
	A373-50- ① -1- N	21W	3000K	700mA	2100Lm	90%
	A373-50- ① -2- N	21W	4000K	700mA	2500Lm	90%

220V~ | 240V~ | IP20 | CRI>90 | L80B10 >60.000h



		P	CCT	I	Flux	LOR
BLACK FOSTER Asymmetric Trimless 15	A373-60- ① -0- N	31,5W	2700K	700mA	2850Lm	90%
	A373-60- ① -1- N	31,5W	3000K	700mA	3150Lm	90%
	A373-60- ① -2- N	31,5W	4000K	700mA	3750Lm	90%

220V~ | 240V~ | IP20 | CRI>90 | L80B10 >60.000h



① *OPTIONS

1	No DIM
2	DIM Push
4	DIM DALI

DIM PHASE CUT PLEASE CONSULT

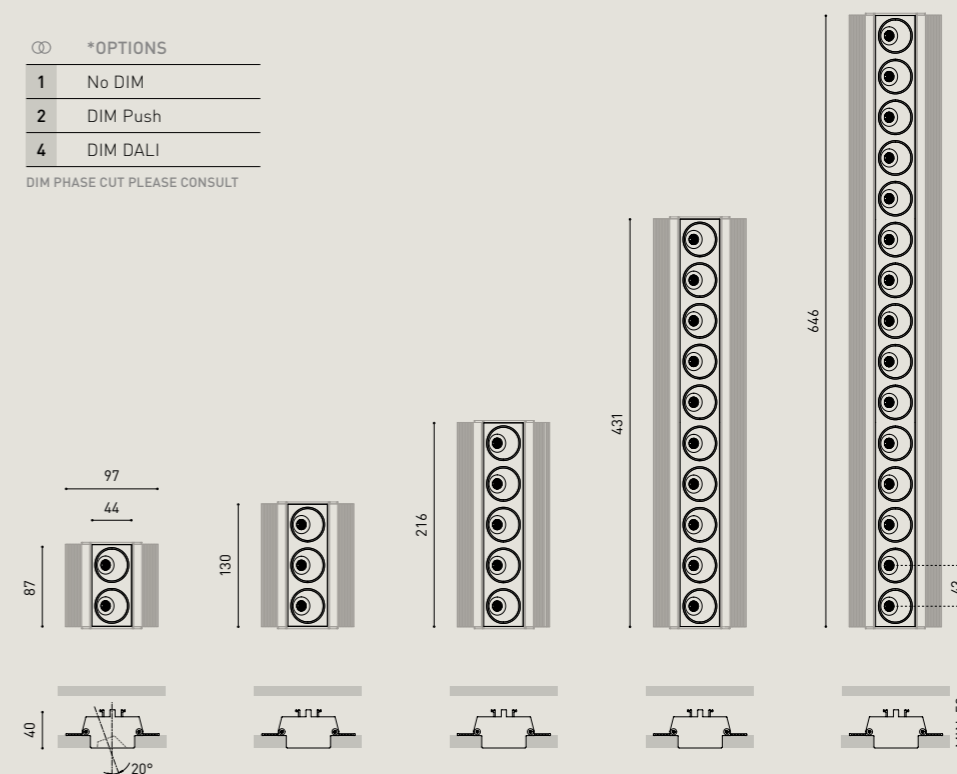

COLOUR | N ■ | MATERIAL | AL | ABS+PC |

PLASTERBOARD CEILING, MANDATORY THICKNESS 12,5mm. RECOMMENDED FOR INSTALLATIONS WHERE THE PROFILE CAN BE INSTALLED BEFORE THE FALSE PLASTERBOARD CEILING.

Ⓢ & Ⓢ » PLEASE CONSULT



BLACK FOSTER SURFACE

		P	CCT	I	Flux
BLACK FOSTER Surface 1	A320-1- ○ -10- WT NT WTMG NTMG	2,1W	2700K	700mA	190Lm
	A320-1- ○ -11- WT NT WTMG NTMG	2,1W	3000K	700mA	210Lm
	A320-1- ○ -12- WT NT WTMG NTMG	2,1W	4000K	700mA	250Lm

220 V~ | IP20 | CRI>90 | L80B10 >60.000h



		P	CCT	I	Flux
BLACK FOSTER Surface 2	A320-2- ○ -10- WT NT WTMG NTMG	4,2W	2700K	700mA	380Lm
	A320-2- ○ -11- WT NT WTMG NTMG	4,2W	3000K	700mA	420Lm
	A320-2- ○ -12- WT NT WTMG NTMG	4,2W	4000K	700mA	500Lm

220 V~ | IP20 | CRI>90 | L80B10 >60.000h



		P	CCT	I	Flux
BLACK FOSTER Surface 3	A320-3- ○ -10- WT NT WTMG NTMG	6,3W	2700K	700mA	570Lm
	A320-3- ○ -11- WT NT WTMG NTMG	6,3W	3000K	700mA	630Lm
	A320-3- ○ -12- WT NT WTMG NTMG	6,3W	4000K	700mA	750Lm

220 V~ | IP20 | CRI>90 | L80B10 >60.000h



○ BEAM	LOR
0	38° 92%
1	19° 90%

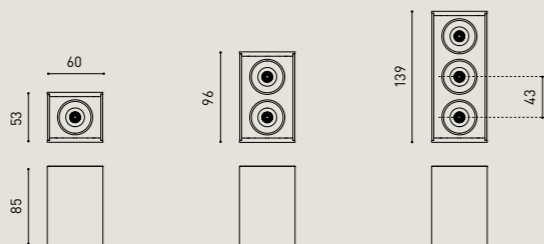

COLOUR | WT □ | NT ■ | WTMG □ | NTMG ■ | MATERIAL | AL | ABS+PC

"The Invisible Black" is only available for NT, NTMG & WTMG colours

		P	CCT	I	Flux
BLACK FOSTER Surface 5	A320-4- ○ -0- WT NT WTMG NTMG	10,5W	2700K	700mA	950Lm
	A320-4- ○ -1- WT NT WTMG NTMG	10,5W	3000K	700mA	1050Lm
	A320-4- ○ -2- WT NT WTMG NTMG	10,5W	4000K	700mA	1250Lm

220 V~ | IP20 | CRI>90 | L80B10 >60.000h



		P	CCT	I	Flux
BLACK FOSTER Surface 10	A320-5- ○ -0- WT NT WTMG NTMG	21W	2700K	700mA	1900Lm
	A320-5- ○ -1- WT NT WTMG NTMG	21W	3000K	700mA	2100Lm
	A320-5- ○ -2- WT NT WTMG NTMG	21W	4000K	700mA	2500Lm

220 V~ | IP20 | CRI>90 | L80B10 >60.000h



		P	CCT	I	Flux
BLACK FOSTER Surface 15	A320-6- ○ -0- WT NT WTMG NTMG	31,5W	2700K	700mA	2850Lm
	A320-6- ○ -1- WT NT WTMG NTMG	31,5W	3000K	700mA	3150Lm
	A320-6- ○ -2- WT NT WTMG NTMG	31,5W	4000K	700mA	3750Lm

220 V~ | IP20 | CRI>90 | L80B10 >60.000h



○ BEAM	LOR
0	38° 92%
1	19° 90%

⊞ *OPTIONS	
1	No DIM
2	DIM Push
4	DIM DALI

DIM PHASE CUT PLEASE CONSULT

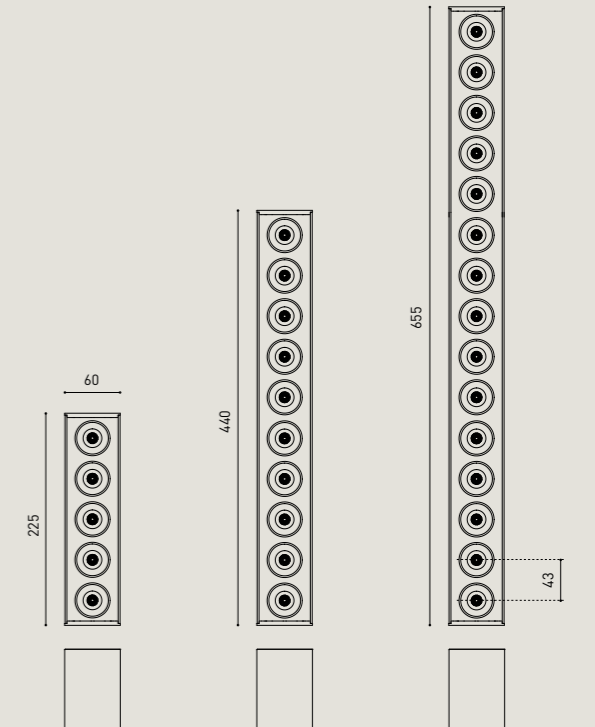

COLOUR | WT □ | NT ■ | WTMG □ | NTMG ■ | MATERIAL | AL | ABS+PC

"The Invisible Black" is only available for NT, NTMG & WTMG colours | OTHER DIM PLEASE CONSULT

⊞ » PLEASE CONSULT



BLACK FOSTER SUSPENSION

		P	CCT	I	Flux
BLACK FOSTER Suspension 1200	A321-1- ○ - ○ -0- WT NT WTMG NTMG	21W	2700K	700mA	1900Lm
	A321-1- ○ - ○ -1- WT NT WTMG NTMG	21W	3000K	700mA	2100Lm
	A321-1- ○ - ○ -2- WT NT WTMG NTMG	21W	4000K	700mA	2500Lm
BLACK FOSTER Suspension 1600	A321-2- ○ - ○ -0- WT NT WTMG NTMG	31,5W	2700K	700mA	2850Lm
	A321-2- ○ - ○ -1- WT NT WTMG NTMG	31,5W	3000K	700mA	3150Lm
	A321-2- ○ - ○ -2- WT NT WTMG NTMG	31,5W	4000K	700mA	3750Lm

220 V~ | IP20 | CRI>90 | L90B10 >60.000h

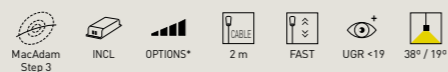

OPTIONAL ACCESSORIES

WIRE TRIMLESS Accessories

FEED

Mains Trimless

A023-00-01- | W | N | NO DIM On Board

Mains Thick Trimless

A023-00-02- | W | N | DALI | Push

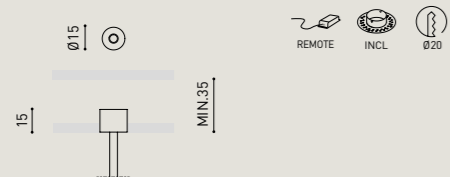

FASTENING

Steel Cable Trimless

A023-00-05- | W | N | 2 Pcs. needed

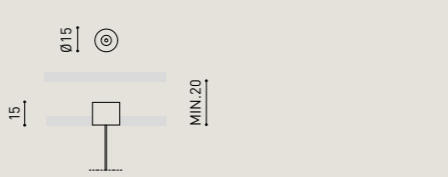

○	BEAM	LOR
0	38°	92%
1	19°	90%

○	*OPTIONS
1	No DIM
2	DIM DALI
3	DIM Push
5	DIM On Board

BLACK FOSTER SUSPENSION 1200

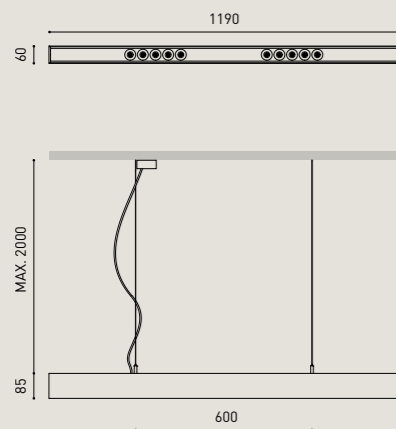

BLACK FOSTER SUSPENSION 1600

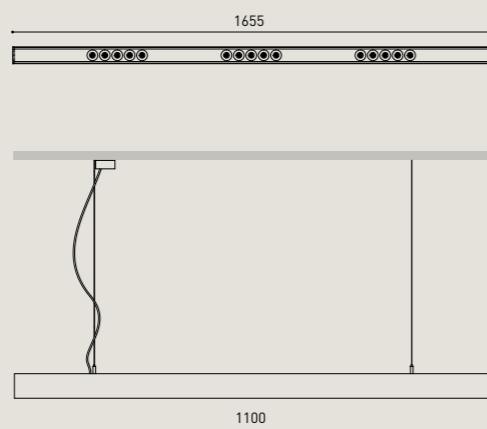

MAINS TRIMLESS

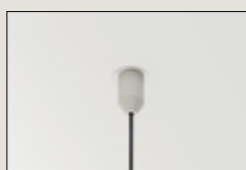

MAINS THICK TRIMLESS

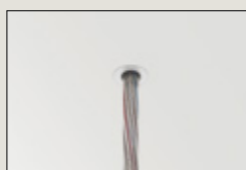

STEEL CABLE TRIMLESS

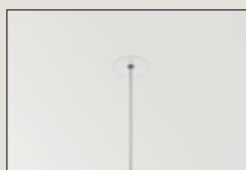

COLOUR | WT □ | NT ■ | WTMG □ | NTMG ■ | W □ | N ■ | MATERIAL | AL | ABS+PC

To achieve a homogeneous light distribution, a distance of 80 cm between the luminaire and the work surface is recommended.

((())) » PLEASE CONSULT



Glosario

P	Potencia		Estabilidad cromática: Pasos MacAdam
CCT	Temperatura de color		Regulable
I	Intensidad de corriente		Equipo no incluido
Flux	Flujo Luminico		Equipo electrónico incluido
L	Longitud (en mm).		Alojamiento en mm para empotrables
AL	Aluminio		Equipo conexionado
PC	Polycarbonato		Longitud del cable
ABS	Acrilonitrilo Butadieno Estireno		Regulación rápida del cable
LOR	<i>Lumen Output Ratio</i> . Relación entre el flujo de salida de la luminaria y el flujo de salida de la fuente de luz		Control por bluetooth
IPXX	Índice de estanqueidad		Dispositivo para alumbrado de emergencias
CRI	Índice de reproducción cromática		Tipo de instalación y dirección del haz de luz
	Lámpara LED		Confort visual. UGR (<i>Unified Glare Rating</i>)
220 V-240	Tensión de alimentación 220-240V		Fabricado en
CE	Marcado CE		Cristal óptico
	Certificado ENEC		Ángulo de basculación
	Clase II		Ángulo de giro
	Clase III		Reflector

Colores

Los valores de iluminación indicados para cada código de referencia corresponden a los resultados obtenidos en los ensayos realizados sobre el primer color mencionado de la lista.

	N Negro mate = RAL 9005 NT Negro texturizado = RAL 9005
	B Blanco = RAL 9016 WT Blanco texturizado = RAL 9016
	WN Blanco - Negro texturizado WN RAL 9016 - RAL 9005
	G Oro = RAL 1036
	WTMG Blanco texturizado - Oro Metalizado*
	NMG Negro mate - Oro Metalizado* NTMG Negro texturizado - Oro Metalizado*

*RAL no disponible. Pintura con nanopartículas metálicas.

Special LED

FOR COMMERCIAL PRODUCT SHOWCASING

Arkoslight ofrece en algunos de sus productos la posibilidad de dotarlos de un LED especial para iluminación orientada a la promoción visual de bienes y productos con finalidad comercial.

Se trata de un LED de alta cromaticidad que persigue destacar los tonos que favorecen la percepción psicológica positiva del objeto iluminado.

Esta fuente de luz LED especial ofrece una paleta de colores más atractiva e intensa, por encima de lo que lo hace un LED convencional. Esto se consigue gracias a la configuración del LED bajo un "parámetro especial de saturación" que consigue que los colores y la textura de los objetos se muestren más atractivos dentro del espectro de luz visible. Para ello se selecciona, en cada caso, el COB pertinente, con su recubrimiento específico de fósforo.

ARKOSLIGHT®

Calle N · Pol. Ind. EL OLIVERAL
46394 Ribarroja del Turia · Valencia (Spain)
Tel. +34 961 667 207 · Fax +34 961 667 054
info@arkoslight.com · www.arkoslight.com
France: +33 182 885 200 · Italia: +39 02 9475 0007
Deutschland: +49 22 182 829 313



LIGHT&LIFE
— DESDE 1984 —